

## System overview

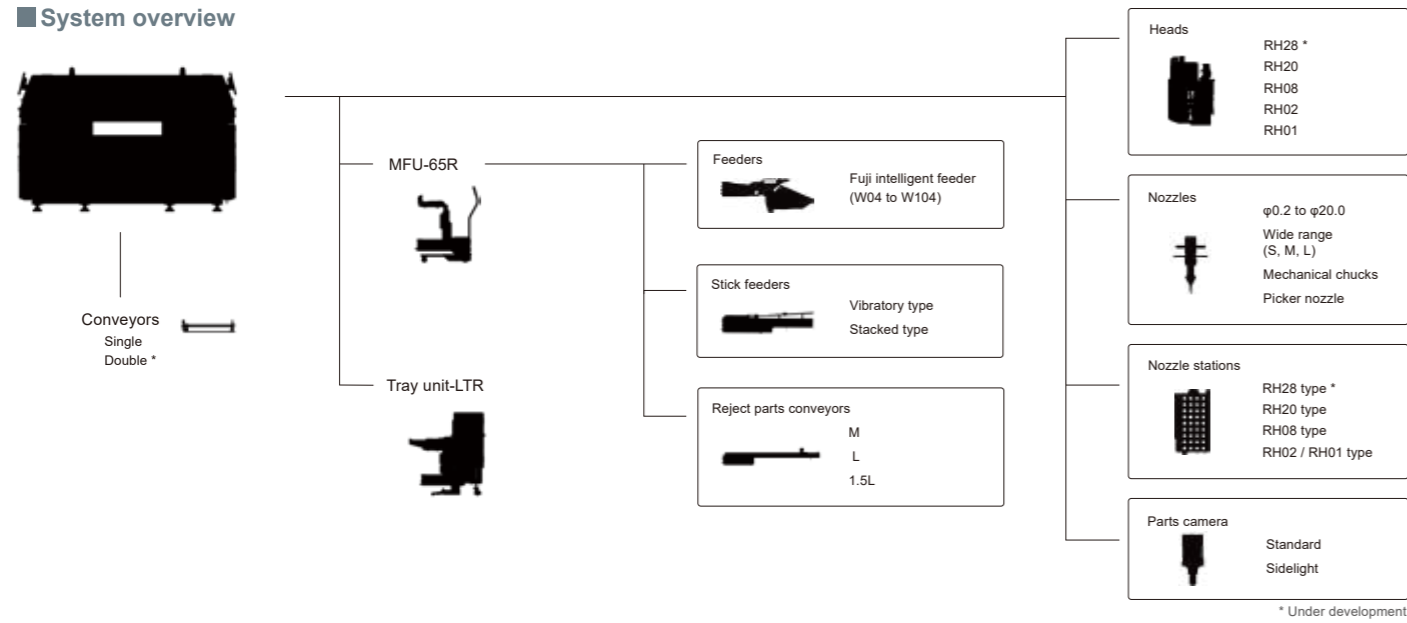

## External dimensions

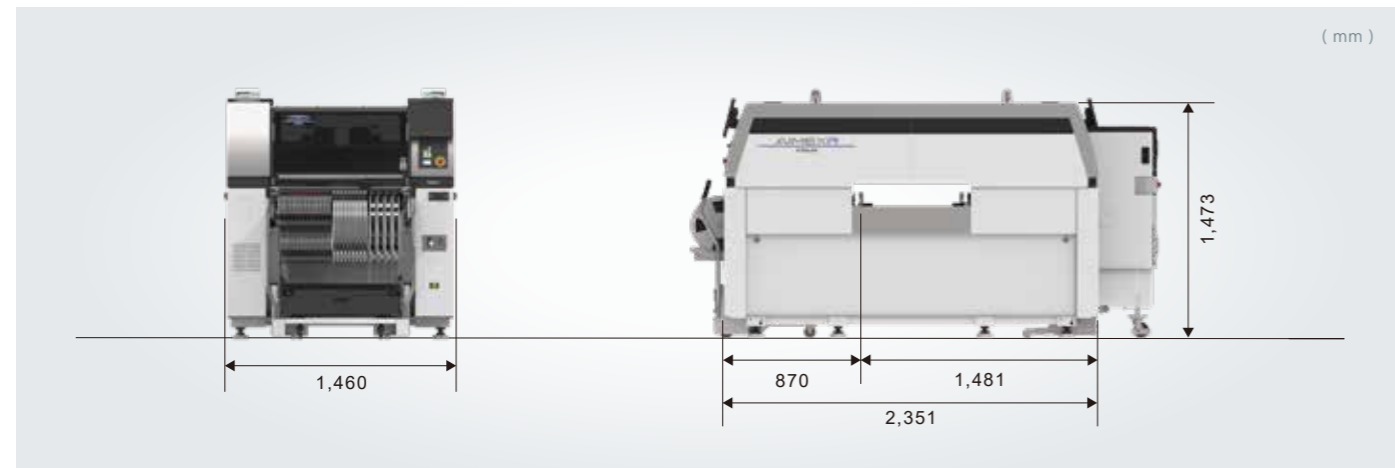

## Specifications

Robot quantity	2R (Twin robot)	
Feeder slot quantity	130	
Panel size (L×W)	Single conveyor	48 x 48 mm to 1,068 x 610 mm
Placing accuracy *1	±0.025 mm Cpk ≥ 1.00	
Weight	1,800 kg	
Power source	3-phase AC200 to 230 V ±10 V (50/60 Hz)	
Air	0.4 MPa	
Air consumption	250 L/min (ANR)	

Heads		RH20	RH08	RH02	RH01
Throughput *1	Normal mode	41,000 cph	22,000 cph	9,000 cph	5,200 cph
	Productivity priority mode	44,500 cph	-	-	-

\*1 Under optimum Fuji conditions.

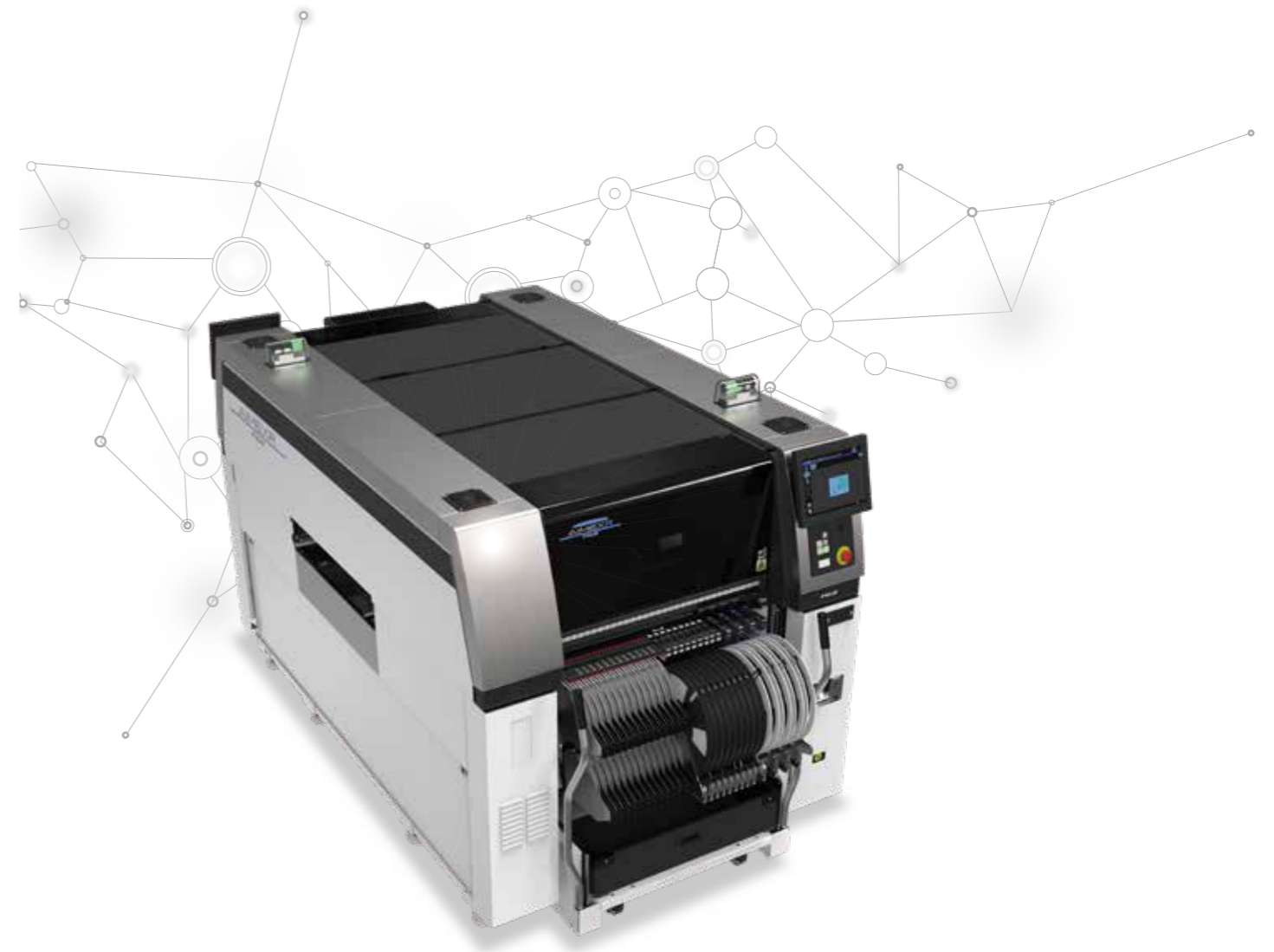

An all-rounder for a new era



FUJI CORPORATION

19 Chausuyama, Yamamachi, Chiryu, Aichi, 472-8686 Japan

Tel: +81-566-81-2110

- The contents of this catalog are subject to change without notice.  
 - The information in this catalog is current as of December, 2023.  
 © 2023 FUJI CORPORATION. All Rights Reserved.

### The fastest in the history of the series

Achieves the fastest placement speed in the history of the series by using advanced XY robots with linear motors. Even greater improvements in area productivity can be expected.



### Further expanded capability

Handling large connectors and heavy parts, and large panels which easily warp are also supported. Even though the machine size is compact, flexible and a wide range of production operation is possible with the machine's extensive capacity.

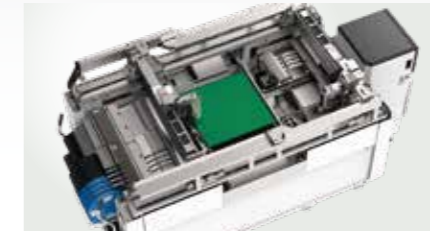

### Full production

Program changes due to sudden production changes and data editing for vision processing errors during production can be supported immediately on the machine. On-machine functions that support editing programs reduce the lead time to ramping up production.



### Supports various types of production

Many available units to support product type changes flexibly. Batch changeover for feeders and nozzles reduces changeover time. Feeders and other supply devices from other Fuji products you may have can also be used, encouraging efficient use of your assets.



### Does not require special skills to perform maintenance

In order to operate production at a high level at all times, maintenance of heads, nozzles, and feeders is essential. Good conditions can be maintained without requiring any skills by automating work using maintenance units.

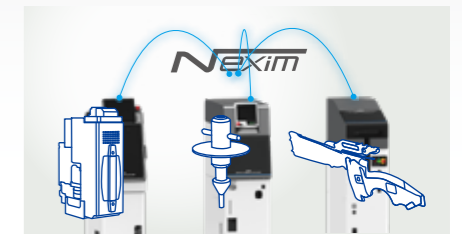

## For a new era All-rounder platform

This high end model mounter is equipped with the latest functions that support various production types flexibly in addition to an advanced platform.

This machine is strong in high mix production and variable-mix variable-volume production such as NPI support for starting new production quickly and immediate support for production type change with batch changeover.

It inherits versatility which is a feature of the AIMEX series and features high productivity including high quality and mass production with new sensing functions.



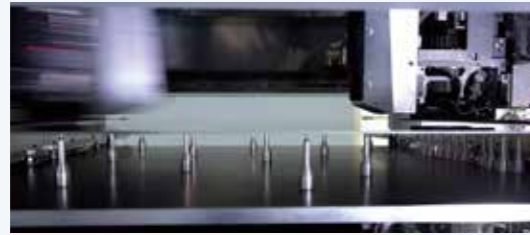

**From high-mix production to mass production**

The throughput in actual production has been improved by using advanced XY robots and the latest heads. Even faster placement is achieved by supporting RH28 heads\*. \* Under development

# High speed Improved productivity

**Towards zero placement defects**

# High quality

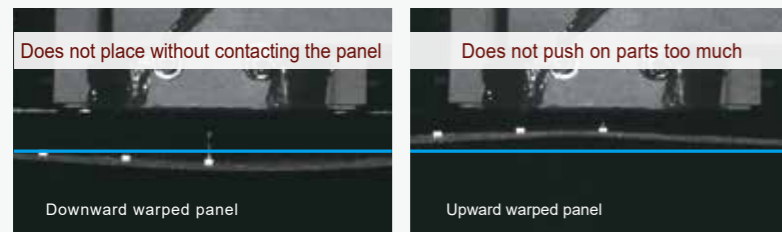
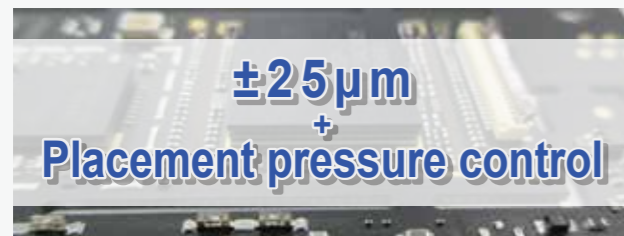

Placement height adjustment

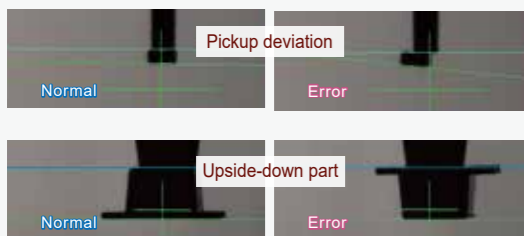

- Check for dropped parts
- Check for parts remaining on nozzle
- Check for stuck nozzles
- Check of the part height
- Check for parts presence

Intelligent parts sensor (IPS)



LCR check



3D coplanarity check

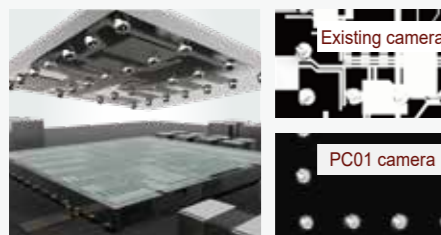

**Offers high accuracy placement as standard**

Placements can be performed with a high accuracy of  $\pm 25 \mu\text{m}$  at all times; there are no constraints for the head type or the part to be placed. Additionally, control the push-in amount during placement and place with the appropriate pressure.

**Not affected by changes in the surface height**

Reliable placement is attained by detecting and adjusting for the panel warpage and individual part differences using advanced functions. Maintain productivity and support even large panels for which it is easy for the warpage to be large (up to 7 mm).

**Checks for tombstoned, missing, and upside-down parts**

The installed IPS system can cater to a wide range of checks, from part pickup stance to parts remaining on nozzles, as well as upside-down checks for minimold parts. It prevents placement defects attributed to packaging, nozzles, and parts.

**Prevents defects associated with part properties**

Placement defects caused by operation errors and defective parts are prevented by checking the electrical properties of chip parts with LCR checks and by checking the leads and bumps on IC parts with coplanarity checks. (Option)

**Places WL-CSPs with high accuracy**

The camera equipped with advanced lighting technology, ensures reliable vision processing of WL-CSPs and other parts for which the background of parts are likely to be captured in acquired images. Also, insertion parts are positioned and inserted accurately by imaging the pin tips. High accuracy placement for various parts is possible.

# High capability

**Support any need**

**Placement heads that demonstrate strong capability in production**



Uses the same latest heads as the NXTR. By expanding the range of parts that can be supported, they contribute to line balancing and flexible production without drops in production rates even when a different set of parts is used in the next production.

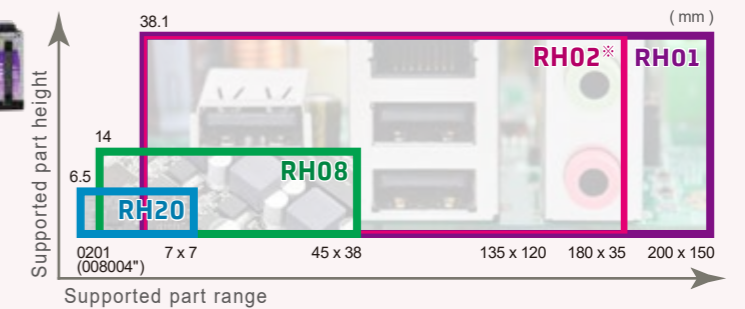

\*Maximum part sizes include 175 x 50 mm and 167 x 74 mm in addition to the above.

**Minimize changeover with large capacity part supply units**

With the large capacity part supply units the machine can hold up to 130 different part types. Shared setups that utilize the large quantity of loaded parts reduce the changeover count and operator work loads.



**Optimal placement actions tailored to the part**

The stable and optimum operation speeds can be selected to suit the parts to be placed. In addition, head operation can be optimized by streamlining Z direction strokes in view of the part height.

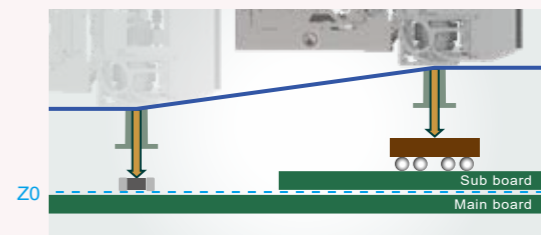

- Multi-level transfer speed
- Shortest Z stroke control

**Operations suitable for the product type**

Optimum operation that matches the production type is possible.

**Large panel production**  
Single conveyor

Expand the possible placement area up to the maximum panel size, 1,068 x 610 mm

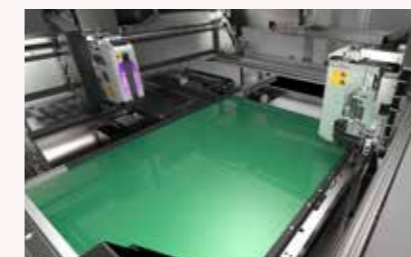

**Simultaneous production of two models**

Double conveyor\*

**Dual lane production with same model**  
Convey the same product type alternately and produce with two robots efficiently



**Dual lane production using different models**  
Convey different product types at the same time and produce with each robot

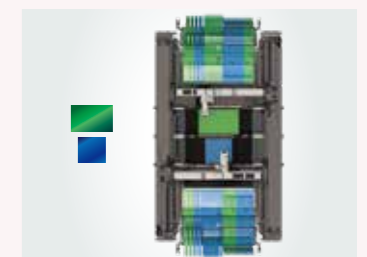

**Allocates backup pins automatically**

Backup pins are automatically allocated only by setting a picker nozzle in the nozzle station. Product type changeover can be supported immediately and production can be restarted in the shortest time. (Option)



- Program-based positioning
- Auto allocation position check

**Place large, odd-form, and heavy parts**

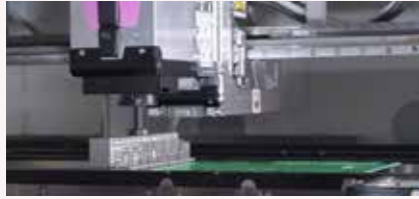

RH01 heads are optimal for large, odd-form, and heavy parts that are seen in electronic panels for such as automotive and server production. Part sizes up to 200 x 150 mm, part heights up to 38.1 mm, and transportable weights up to 350 g are supported.

**Transfer flux**



Transfers flux\* to bumped parts such as BGAs and WL-CSPs. High-speed transfer using an RH20 head is also possible. In addition to flux, other materials such as solder paste can also be used. \* Under development

**Supply stick parts**

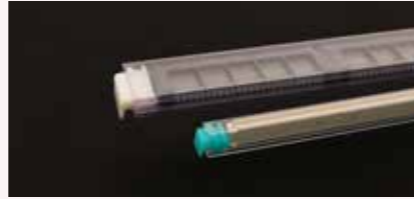

With stacked stick feeders, non-stop supply is possible by stacking stick parts. Also, the vibratory stick feeder 3 in which up to five types of parts can be loaded can also be selected.

**Edit on the machine and ramp up production**



Automatic generation and editing of part data are possible on the machine. This improves work efficiency and supports ramping up the next production.

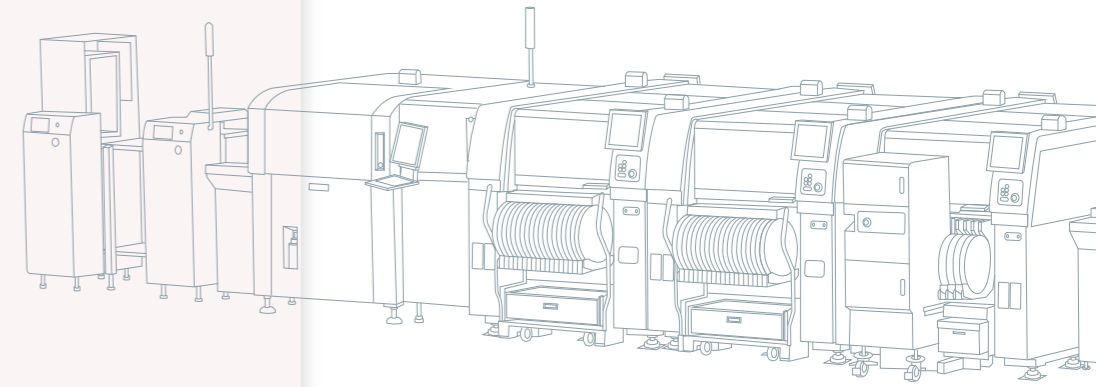

- Correct vision processing errors
- Automatic vision data generation
- Place specified sequences

**Support any need**

# Stable operation

- Collects logs automatically
- Saves all images
- On-machine editing
- Multiple language support
- Remote operation
- Responds to network issues\*

\* Under development

**Towards non-stop production**

By automatically saving logs and image data, signs of issues that would cause machine stops and information that would lead to problem solving is not missed, leading to error prevention and faster recovery times.

**Enhanced fault tolerance**

Even if a communication failure with the integrated production system, Nexim occurs, production can be continued on the line independently. Line stoppages are prevented to support stable production.\* \* Under development

**Reliable maintenance**

Maintenance using automation tools for heads, feeders, and nozzles is possible. Reliable maintenance that does not depend on operator skill greatly reduces the work time. Also, maintenance guidance that matches the operating conditions makes it possible to perform maintenance at the optimal timing.

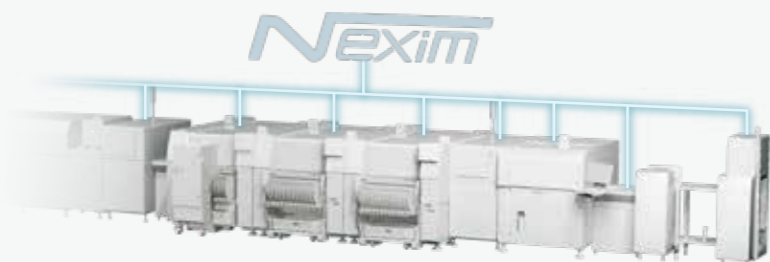

**Maximize machine operation**

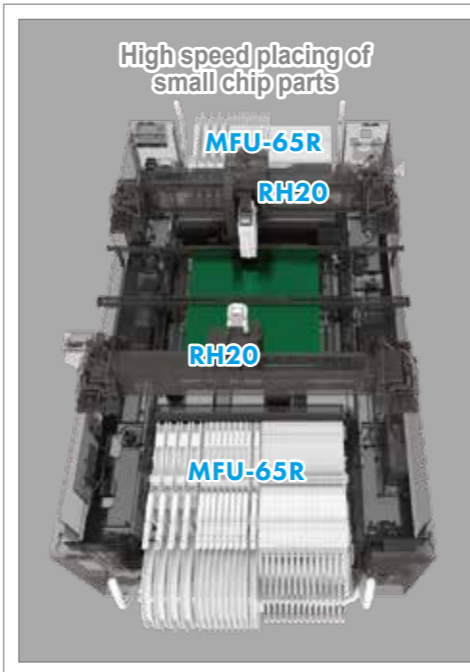

Production method: Dual lane production\*

Supported panel size: 48 x 48mm to 1,068 x 280mm

Supported part size: 0201 (008004") to 7 x 7 mm, height: 6.5 mm

\* Under development

## Sample machine configurations

Production method: Single lane production

Supported panel size: 48 x 48mm to 1,068 x 610mm

Supported part size: 0402 (01005") to 200 x 150 mm, height: 38.1 mm

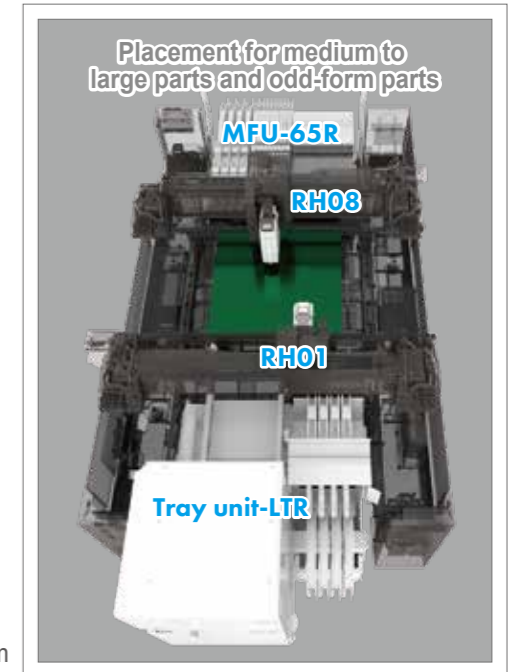

**Improved energy efficiency**

The machine power consumption has been reduced by 10%\* by using highly efficient motors. \* Measured under conditions at Fuji.

**Initiatives for environment conservation**

We are reviewing our painting process and efforts are being made to reduce the environmental impact.



# SDGs

## Environmental activities